

DOCUMENT No: 200-000-523

REVISION HISTORY

REV	DESCRIPTION	REF. No.	DATE	DRWN BY:	RWD BY:
0	Initial Release	WO# 1335D	2016-07-18	AN	
1	Updated to new design. Foundations removed.	WO# 1964D-2	2018-11-12	WM	LL

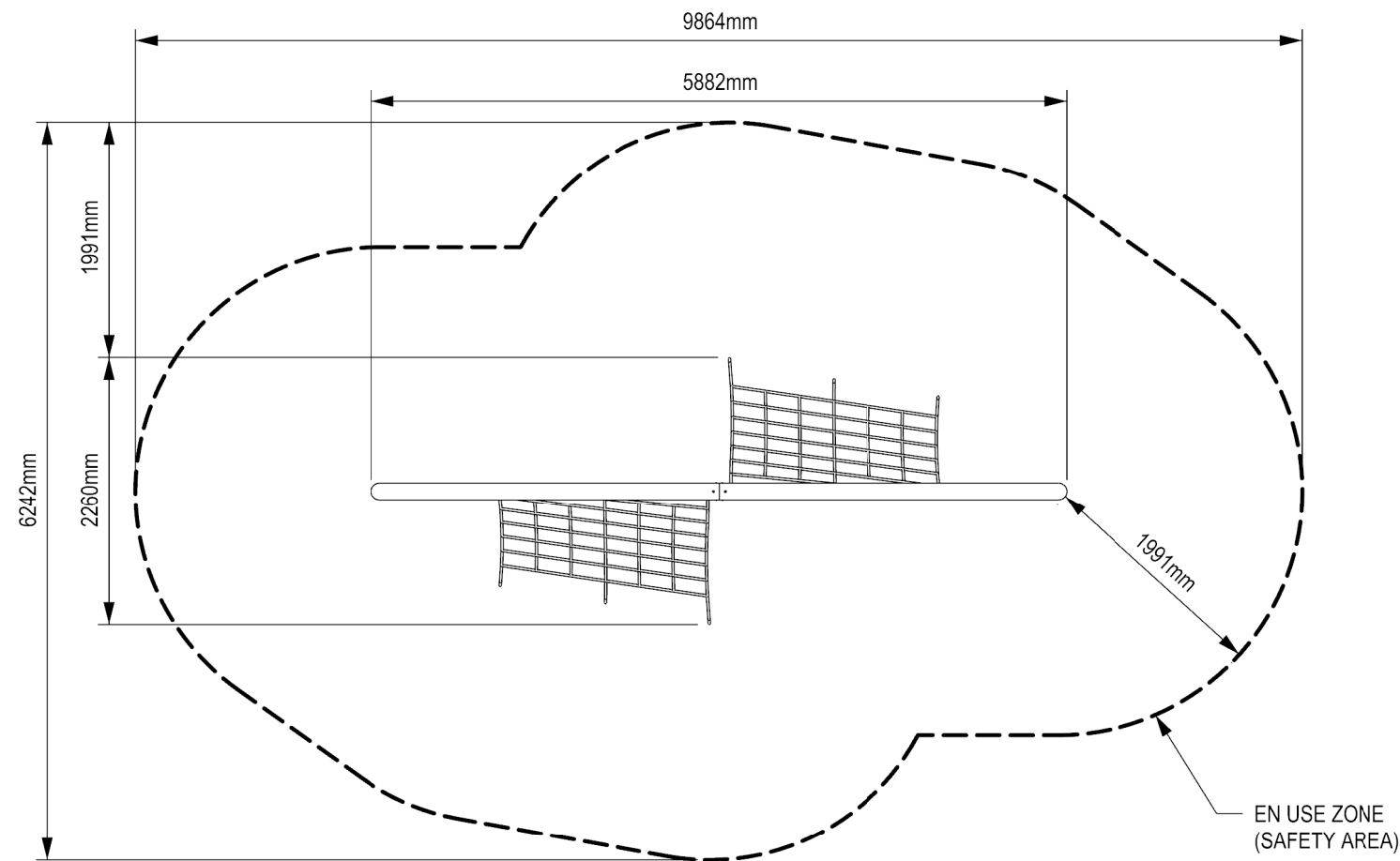

EN USE ZONE - PLAN VIEW

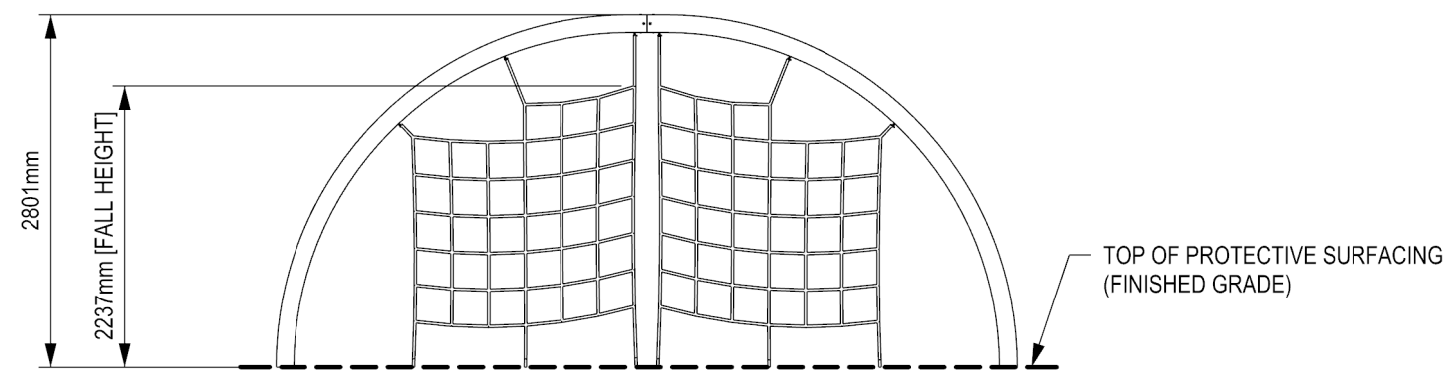

ELEVATION VIEW

CLIENT: STOCK

PROJECT NAME: STOCK

PRODUCT NO: DX-918

DRAWING TITLE:
NEBULA MINI IV EN
USE ZONE (SAFETY AREA)
DRAWING

REV:	SHEET:	SHEET SIZE:	SCALE:
1	1 OF 1	PA3	NTS

DESIGNED BY: DATE:

DRAWN BY: A. Nisbet DATE: 2016-07-18

CHECKED BY: W. McNair DATE: 2018-11-15

REVIEWED BY: DATE:

APPROVED BY: DATE:

DYNAMO
PLAYGROUNDS



Local: 613-446-0030
Toll free: 800-790-0034
Email: info@dynamoplaygrounds.com
Fax: 613-446-0034
URL: www.dynamoplaygrounds.com

REVISION HISTORY					
REV	DESCRIPTION	REF. No.	DATE	DRWN BY:	RWD BY:
0	Initial release for Lincoln park installation	WO# 1335D	2016-09-21	AN	
1	Revised for standardized arch bend.	WO# 1964D-2	2018-11-14	WMc	LL

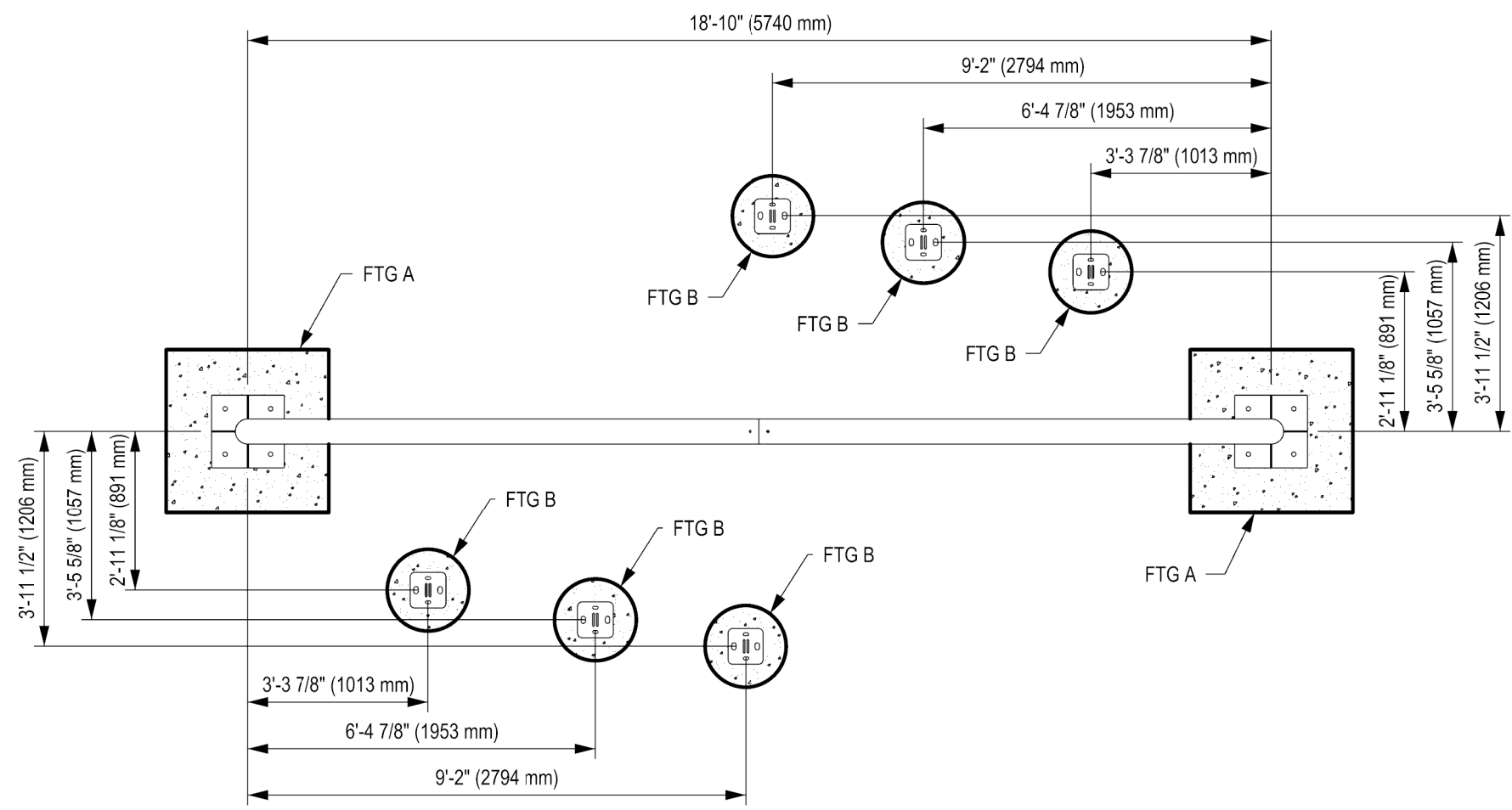

FOUNDATION LAYOUT, PLAN VIEW

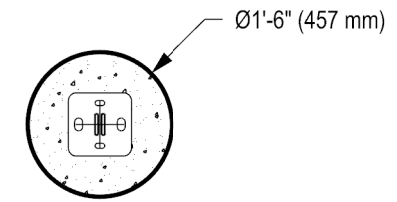

FTG B, PLAN VIEW

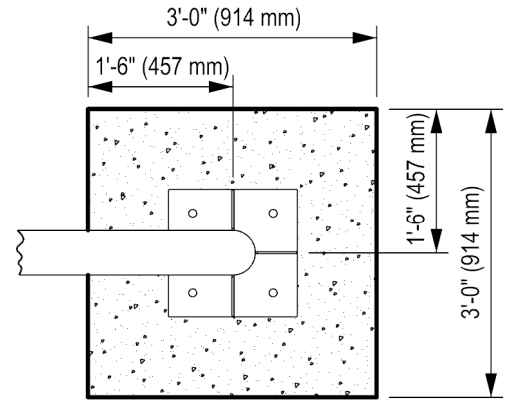

FTG A, PLAN VIEW

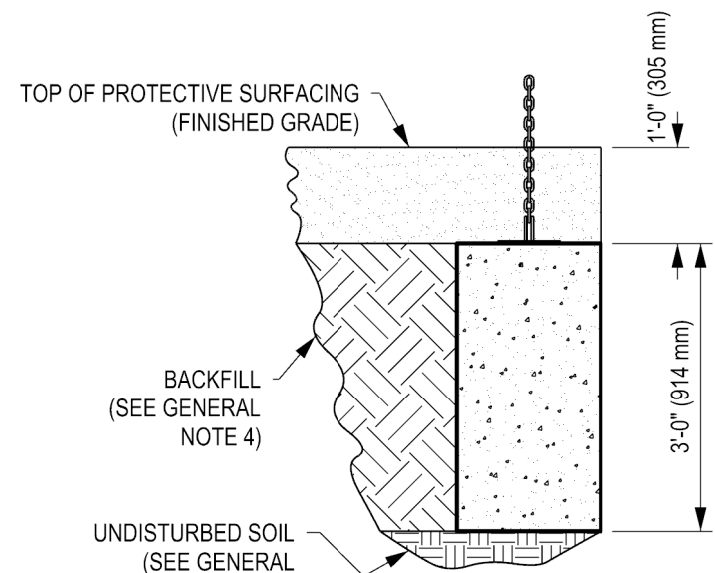

FTG B, ELEVATION VIEW

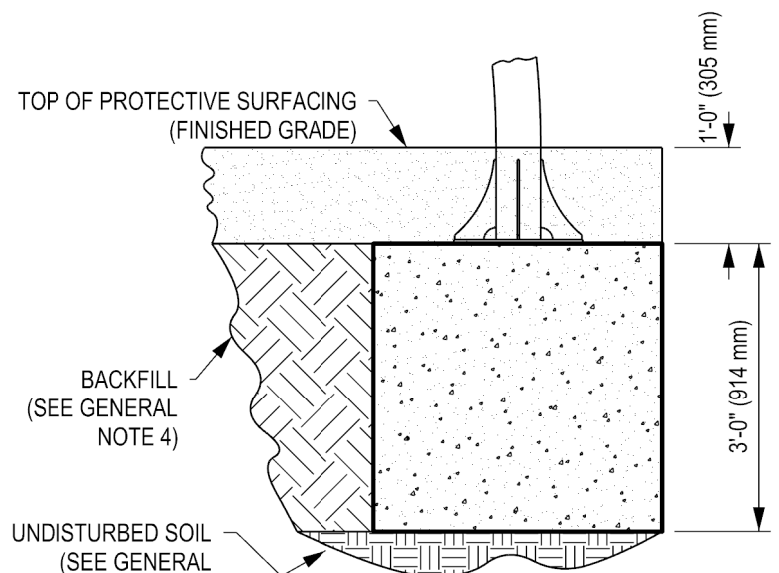

FTG A, ELEVATION VIEW

GENERAL NOTES:

1. THE FOUNDATION IN THE DRAWING TO BE USED AS A MINIMUM GUIDELINE. CHECK WITH LOCAL ENGINEERS
2. THE CONCRETE SHALL BE GRADE C25 (CHARACTERISTIC STRENGTH OF 3500 PSI AT 28 DAYS) MINIMUM.
3. THE FOUNDATION SHALL BE PLACED ON FIRM, UNDISTURBED SOIL SURFACE. WHEREVER EXCAVATION OCCURS BELOW THE DESIGNED FOUNDATION LEVEL, WELL COMPACTED BACK FILL OR LEAN CONCRETE SHALL BE USED FOR LEVELING.
4. BACKFILLING FOR FOUNDATION SHALL BE PLACED EVENLY IN 6" (150mm) LAYERS. LAYERS SHALL BE WELL COMPACTED.
5. THE FOUNDATION DESIGN IS SUITABLE FOR SOIL WITH A BEARING CAPACITY OF 1600 PSF (80 KPA) AND ABOVE.
6. THE FOUNDATION DESIGN IS SUITABLE FOR SOIL WITH FROST LINE OF 4' (1200 MM) OR LESS.

ENGINEERING SEAL:

CLIENT:	STOCK
PROJECT NAME:	STOCK
PRODUCT NO:	DX-918

DRAWING TITLE:
**NEBULA MINI IV
FOUNDATION DRAWING**

REV:	SHEET:	SHEET SIZE:	SCALE:
1	1 OF 1	PA3	NTS

DESIGNED BY:	J. Zhai	DATE:	2018-11-12
DRAWN BY:	W. McNair	DATE:	2018-11-14
CHECKED BY:	L. Leblanc	DATE:	2018-11-15
REVIEWED BY:	J. Zhai	DATE:	2018-11-15
APPROVED BY:		DATE:	

DYNAMO
PLAYGROUNDS

Local: 613-446-0030
Toll free: 800-790-0034
Email: info@dynamoplaygrounds.com
Fax: 613-446-0034
URL: www.dynamoplaygrounds.com